

MODEL	CODICE ATIM	Description	M	P min	H min	S1	E	Z min	S min	Цена в лева с ДДС
SIESTA	411/78.1155.T	Mechanism + cover caps	450	mm 550	120	15/20	mm 750	mm 405	16	587.43
SIESTA	411/78.1150.T	Mechanism + cover caps	600	mm 550	120	15/20	mm 750	mm 555	16	587.43
SIESTA	411/78.1160.T	Mechanism + cover caps	900	mm 550	120	15/20	mm 750	mm 855	16	587.43
SIESTA	411/78.1170.T	Mechanism + cover caps	1200	mm 550	120	15/20	mm 750	mm 1155	16	587.43

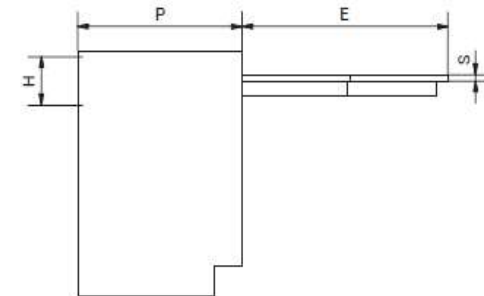

Link video: <https://youtu.be/VqXFaeCm6Qg>

MODEL	CODICE ATIM	Description	M	P min	H min	S1	E	Z min	S min	Цена в лева с ДДС
BRUNCH	411/78.1100.T	Mechanism + cover caps	600	540 mm	120	15/20	1060	555	16	1,241.84
BRUNCH	411/78.1110.T	Mechanism + cover caps	900	540 mm	120	15/20	1060	855	16	1,241.84
BRUNCH	411/78.1120.T	Mechanism + cover caps	1200	540 mm	120	15/20	1060	1155	16	1,241.84

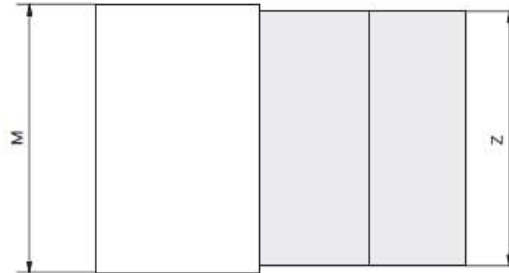
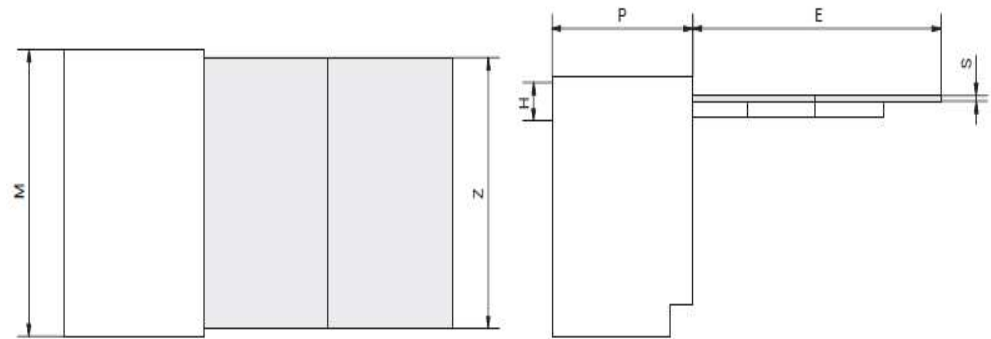

Link video:

<https://youtu.be/hJWGP63e2H4>

MODEL	CODICE ATIM	Description	M	P min	H min	S1	E	Z min	S min	Цена в лева с ДДС
COCKTAIL	411/78.1155.ET	Mechanism + cover caps	mm 450	mm 540	mm 120	mm 15/20	mm 753	mm 405	mm 16	472.65
COCKTAIL	411/78.1150.ET	Mechanism + cover caps	mm 600	mm 540	mm 120	mm 15/20	mm 753	mm 555	mm 16	472.65
COCKTAIL	411/78.1160.ET	Mechanism + cover caps	mm 900	mm 540	mm 120	mm 15/20	mm 753	mm 855	mm 16	472.65
COCKTAIL	411/78.1170.ET	Mechanism + cover caps	mm 1200	mm 540	mm 120	mm 15/20	mm 753	mm 1155	mm 16	472.65

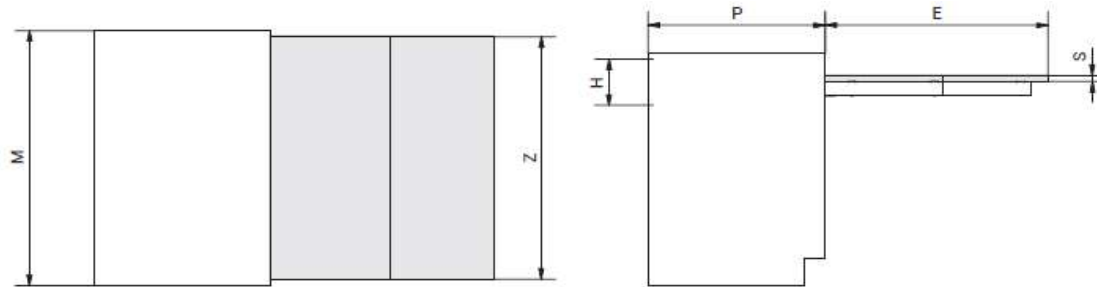

Link video: <https://youtu.be/Ae-l2-r6LS8>

MODEL	CODICE ATIM	Description	M	P min	H min	S1	E	Z min	S min	Цена в лева с ДДС
LUNCH	411/78.1105.ET	Mechanism + cover caps	mm 450	mm 540	mm 120	mm 15/20	mm 895	mm 405	mm 16	587.20
LUNCH	411/78.1100.ET	Mechanism + cover caps	mm 600	mm 540	mm 120	mm 15/20	mm 895	mm 555	mm 16	587.20
LUNCH	411/78.1110.ET	Mechanism + cover caps	mm 900	mm 540	mm 120	mm 15/20	mm 895	mm 855	mm 16	587.20
LUNCH	411/78.1120.ET	Mechanism + cover caps	mm 1200	mm 540	mm 120	mm 15/20	mm 895	mm 1155	mm 16	587.20

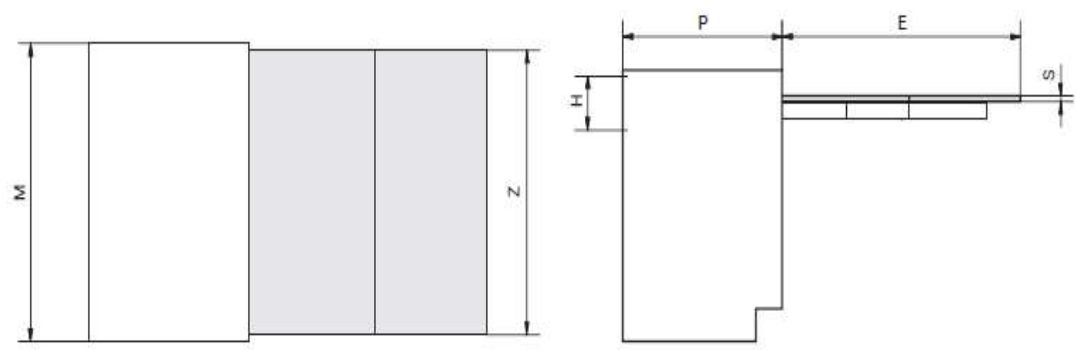

Link video: <https://youtu.be/dhJvjVSncI>

MODEL	CODICE ATIM	Description	M	P min	H min	S1	E	Z min	S min	Цена в лева с ДДС
LUNCH REVERSE	411/78.1105.RT	Mechanism + cover caps	mm 450	mm 540	mm 120	mm 15/20	mm 1045	mm 405	mm 16	562.54
LUNCH REVERSE	411/78.1100.RT	Mechanism + cover caps	mm 600	mm 540	mm 120	mm 15/20	mm 1045	mm 555	mm 16	562.54
LUNCH REVERSE	411/78.1110.RT	Mechanism + cover caps	mm 900	mm 540	mm 120	mm 15/20	mm 1045	mm 855	mm 16	562.54
LUNCH REVERSE	411/78.1120.RT	Mechanism + cover caps	mm 1200	mm 540	mm 120	mm 15/20	mm 1045	mm 1155	mm 16	562.54

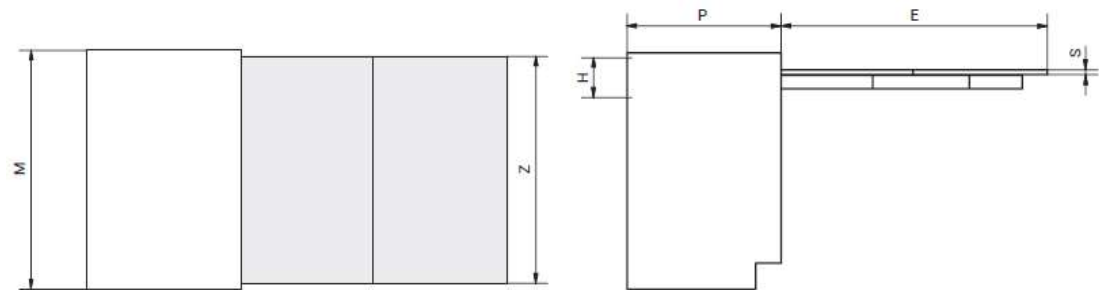

MODEL	CODICE ATIM	Description	M	P min	H min.	S1	E	Z	S min	Цена в лева с ДДС
SHOT	411/78.1130.25	Mechanism	mm 450/1200	mm 560	mm 90	mm 15/20	mm 490	mm 405/1155	mm 16	368.09
SHOT FOLDING	411/78.1130.25F	Mechanism	mm 450/1200	mm 560	mm 90	mm 15/20	mm 490	mm 405/1155	mm 16	368.09
SHOT	411/78.1130.T	Mechanism + cover caps	mm 450/1200	mm 560	mm 90	mm 15/20	mm 490	mm 405/1155	mm 16	383.35

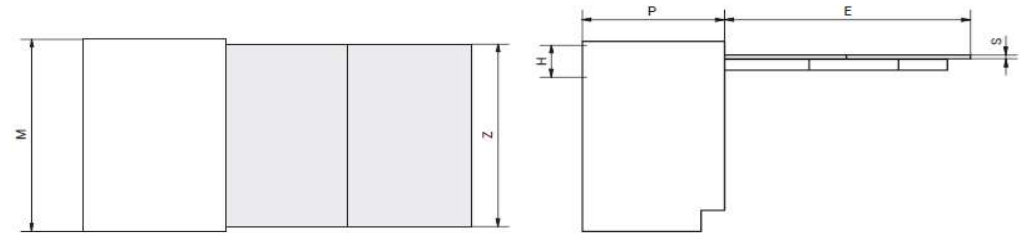

CODICE CODE	M	P MIN	H MIN	S1	E	Z MIN	S MIN	SILENT
411/78.1100.25 R	450/1200	540	120	15/20	1045	405/1155	16	78.1100.25 R

Valori espressi in millimetri. Value expressed in millimetres.

MODEL	CODICE ATIM	Description	M min	P min	H min	S1	E min	Z min	S min	Цена в лева с ДДС
DESK	411/78.0005.02	Mechanism	mm 450	mm 150	mm 200	mm 15/20	mm 350	mm 445	mm 18	670.26
COPPIA COVER DESK nero	2.5541204.10	Cover black								55.65
COPPIA COVER DESK bianco	2.5541204.12	Cover white								55.65

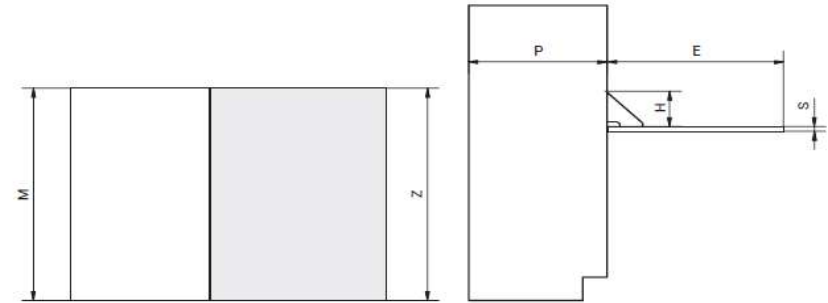

Link video:

<https://youtu.be/QE2PoYI7yp0>

MODEL	CODICE ATIM	Description	M	P min	H min	S1	E	Z min	S	ST	Цена в лева с ДДС
OPLA'	411/78.1700.T	Mechanism + cover caps	mm 450	mm 540	mm 75	mm 15/20	mm 500	mm 405	mm 15/20	mm 15/20	632.11
OPLA'	411/78.1710.T	Mechanism + cover caps	mm 600	mm 540	mm 75	mm 15/20	mm 500	mm 555	mm 15/20	mm 15/20	632.11
OPLA'	411/78.1720.T	Mechanism + cover caps	mm 900	mm 540	mm 75	mm 15/20	mm 500	mm 855	mm 15/20	mm 15/20	632.11
OPLA'	411/78.1730.T	Mechanism + cover caps	mm 1200	mm 540	mm 75	mm 15/20	mm 500	mm 1155	mm 15/20	mm 15/20	632.11

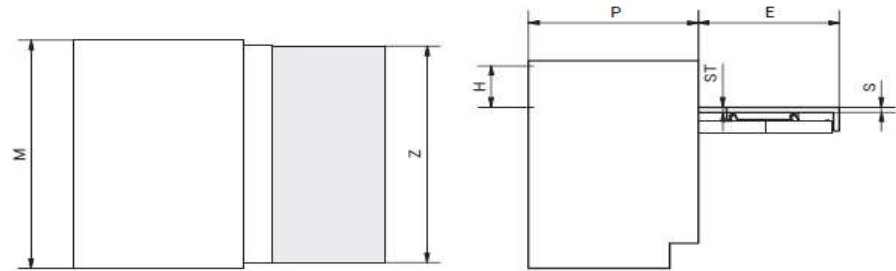

Link video: <https://youtu.be/aCeZMo43dhM>

MODEL	CODICE ATIM	Description	M	P min	H min	S1	E	Z min	S	Цена в лева с ДДС
OPLA' FOLDING	78.1700.FT	Mechanism + cover caps	mm 600	mm 540	mm 75	mm 18	mm 500	mm 555	mm 18	805.72
OPLA' FOLDING	78.1710.FT	Mechanism + cover caps	mm 900	mm 540	mm 75	mm 18	mm 500	mm 855	mm 18	805.72
OPLA' FOLDING	78.1720.FT	Mechanism + cover caps	mm 1200	mm 540	mm 75	mm 18	mm 500	mm 1155	mm 18	805.72

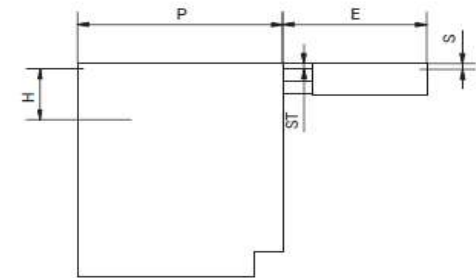
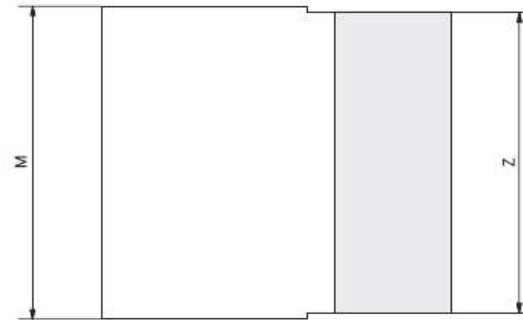

Link video:

<https://youtu.be/G2mNNWhJ6hA>

MODEL	CODICE ATIM	Description	M	P min	H min	S1	E	Z min	S	Цена в лева с ДДС
HOMEWORK	411/78.1200.T	Mechanism + cover caps	mm 600	540 mm	mm 54	mm 15/20	mm 1100	mm 555	mm 16	756.52
HOMEWORK	411/78.1210.T	Mechanism + cover caps	mm 900	540 mm	mm 54	mm 15/20	mm 1100	mm 855	mm 16	756.52
HOMEWORK	411/78.1220.T	Mechanism + cover caps	mm 1200	540 mm	mm 54	mm 15/20	mm 1100	mm 1155	mm 16	756.52

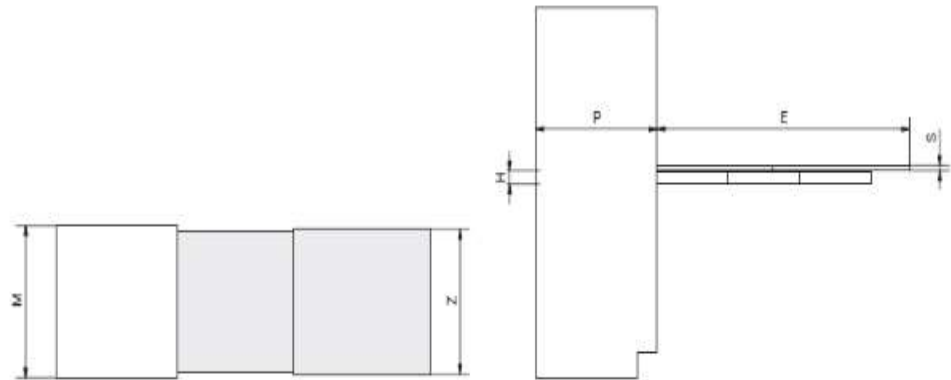

Link video: <https://youtu.be/hJMrfV0JhI4>

MODEL	CODICE ATIM	Description	M	P	H min	S1	E	Z	S MIN	Цена в лева с ДДС
COOK	78.1490.25	Mechanism + cover cap + wodden box	600	520	120	15/20	720	555	18	1,341.43
COOK	78.1491.25	Mechanism + cover cap + wodden box	900	520	120	15/20	720	855	18	1,570.92
COOK	78.COOK.T	Mechanism + cover cap		520	120	15/20	720	555	18	577.70

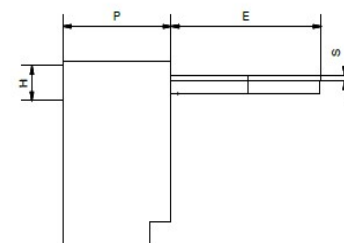
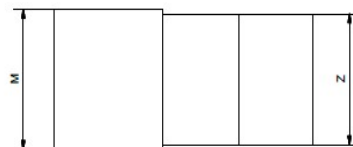

MODEL	CODICE ATIM	Description	M	P	H min	S1	E	Z min	S min	Цена в лева с ДДС
FUNCTIONAL	78.1493.25	Mechanism + cover cap + wodden box	600	450	110	15/20	350	555	16	966.72
FUNCTIONAL	78.1494.25	Mechanism + cover cap + wodden box	900	450	110	15/20	350	855	16	1,118.30
FUNCTIONAL	78.FUNCTIONAL.T	Mechanism + cover cap	600-900	450	110	15/20	350	555	16	382.93

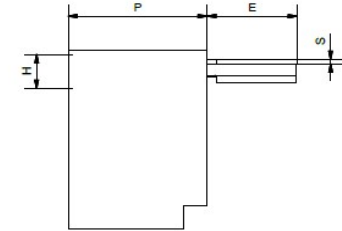
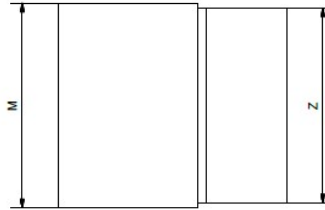

MODEL	CODICE ATIM	Description	M	P	H min	S1	E	Z	S min	Цена в лева с ДДС
BASKET K	78.1497.T		450	450	690	15/20	350	405	16	418.70
BASKET K	78.1498.T		600	450	690	15/20	350	555	16	424.00

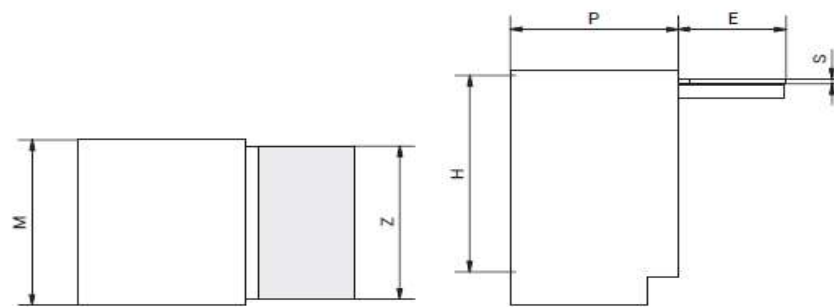
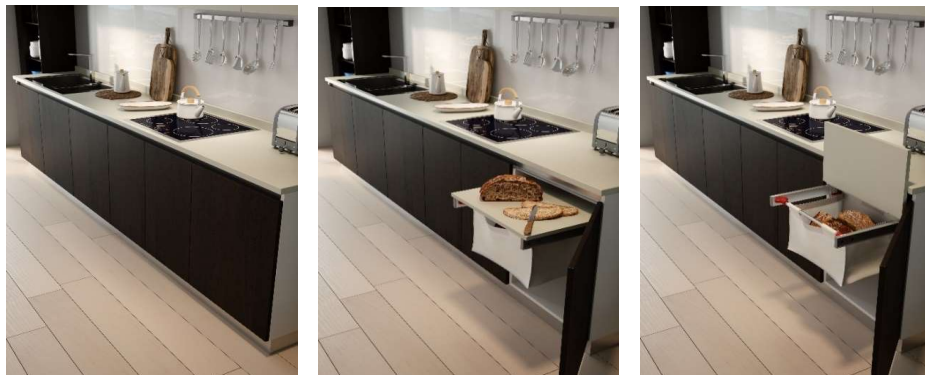

MODEL	CODICE ATIM	Description	M	P min	H min.	S1	E	Z min	S	Цена в лева с ДДС
ZIP	411/78.1260.22	Mechanism + cover caps	450	550	120	15/20	900	405	18	1,563.50
ZIP	411/78.1261.22	Mechanism + cover caps	600	550	120	15/20	900	555	18	1,563.50
ZIP	411/78.1262.22	Mechanism + cover caps	900	550	120	15/20	900	855	18	1,563.50

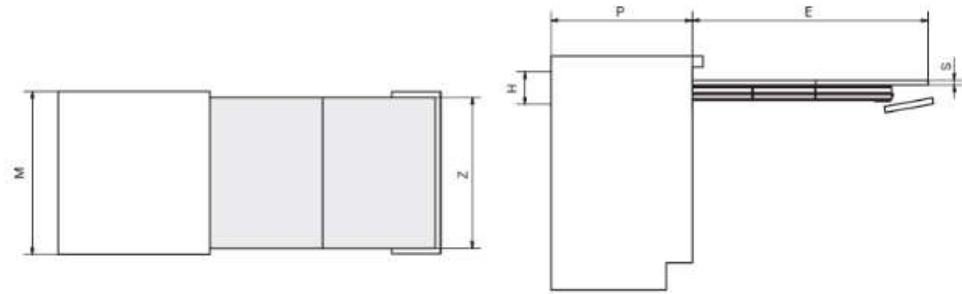

MODEL	CODICE ATIM	Description	M	P min	H min.	S1	E	Z min	S	Цена в лева с ДДС
READY	411/78.1140.T	Mechanism + cover caps	450	500	170	15/20	800	405	16/18	988.40
READY	411/78.1141.T	Mechanism + cover caps	600	500	170	15/20	800	555	16/18	988.40
READY	411/78.1142.T	Mechanism + cover caps	900	500	170	15/20	800	855	16/18	988.40

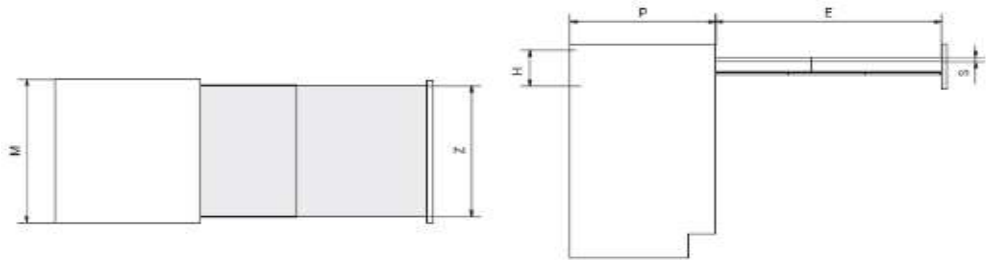

MODEL	CODICE ATIM	Description	M	P min	H min	S1	E	Z min	S min	T	Цена в лева с ДДС
T-ABLE	411/78.1900.T	Mechanism + cover caps	mm 600	mm 540	mm 120	mm 15/20	mm 900	mm 555	mm 16	mm 745/840	950.63
T-ABLE	411/78.1910.T	Mechanism + cover caps	mm 900	mm 540	mm 120	mm 15/20	mm 900	mm 855	mm 16	mm 745/840	950.63
T-ABLE	411/78.1920.T	Mechanism + cover caps	mm 1200	mm 540	mm 120	mm 15/20	mm 900	mm 1155	mm 16	mm 745/840	950.63

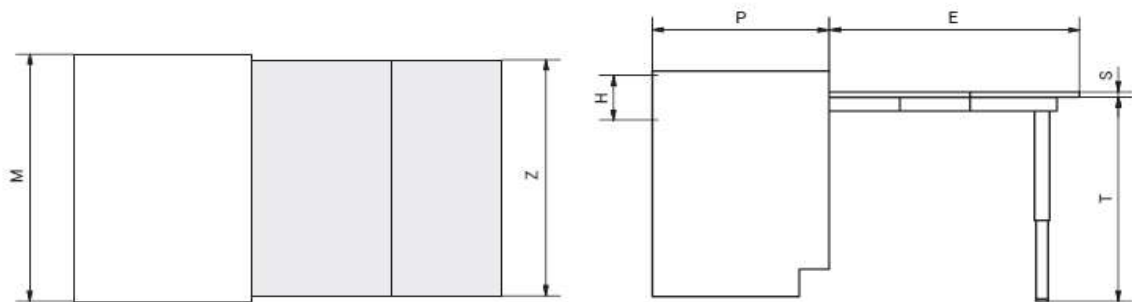

Link video:

<https://youtu.be/JSEFJSiw1nI>

MODEL	CODICE ATIM	Description	M	P min	H min	S1	E	Z min	S min	T	Цена в лева с ДДС
T-ABLE XL	411/78.1900.XT	Mechanism + cover caps	mm 600	mm 520	mm 150	mm 15/20	mm 1310	mm 555	mm 16	mm 700/795	1,109.03
T-ABLE XL	411/78.1910.XT	Mechanism + cover caps	mm 900	mm 520	mm 150	mm 15/20	mm 1310	mm 855	mm 16	mm 700/795	1,109.03
T-ABLE XL	411/78.1920.XT	Mechanism + cover caps	mm 1200	mm 520	mm 150	mm 15/20	mm 1310	mm 1155	mm 16	mm 700/795	1,109.03

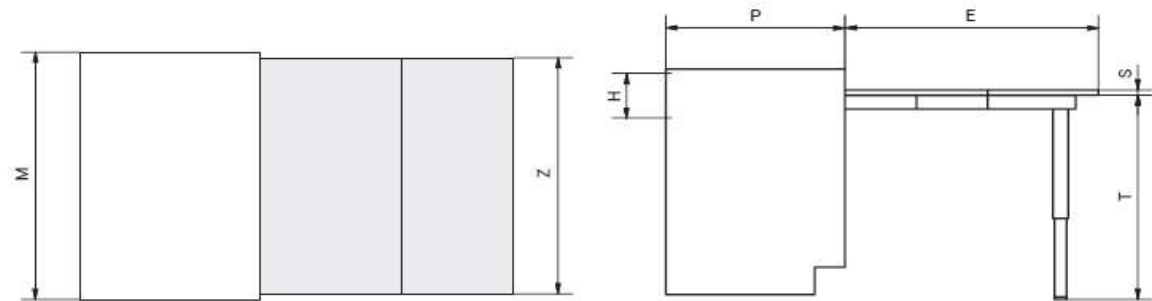

Link video:

<https://youtu.be/JSEFJSiw1nI>

MODEL	CODICE ATIM	Description	M	H min.	S1 min	T	E	Z min	S min	Цена в лева с ДДС	Note
JUST	411/78.1990.25	Mechanism	600	80	40	855	750	600	18	343.44	
JUST	411/78.1990.25 P	Mechanism	600	80	40	855	750	600	18	451.83	с амортисьор

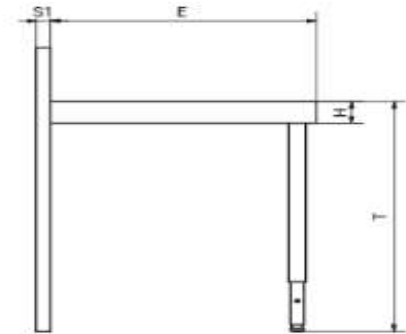

MODEL	CODICE ATIM	Description	L module	P min	H min	S1	E	Z min	S min	T	Цена в лева с ДДС
T-BENCH	411/78.1950.T	Mechanism + cover caps	450	540 mm	mm 120	mm 15/20	mm 870	mm 405	mm 16	mm 385/410	859.13
T-BENCH	411/78.1960.T	Mechanism + cover caps	600	540 mm	mm 120	mm 15/20	mm 870	mm 555	mm 16	mm 385/410	859.24

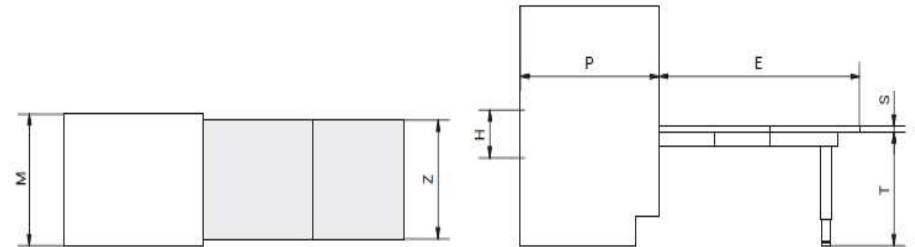

Link video: <https://youtu.be/g-Dxn9KFHvI>

MODEL	CODICE ATIM	L module	Description	P min	H min	S1	E	Z min	S min	T	Цена в лева с ДДС
T-BENCH XL	411/78.1960.XT	mm 600	Mechanism + cover caps	mm 520	mm 150	mm 15/20	mm 1310	mm 555	mm 16	mm 385/410	1,073.52

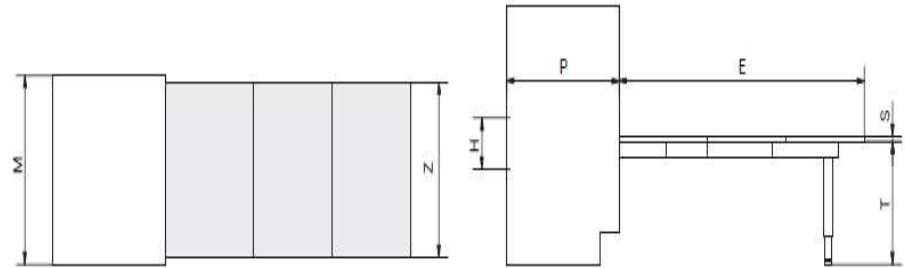

MODEL	CODICE ATIM	Description	M	P min	H min	S1	E	Z min	S min	T	Цена в лева с ДДС
PARTY	411/78.1500.T	Mechanism + cover caps	mm 600	560 mm	mm 150	mm 16/19	mm 1380	mm 557	mm 16	mm 725/820	1,771.27
PARTY	411/78.1510.T	Mechanism + cover caps	mm 900	560 mm	mm 150	mm 16/19	mm 1380	mm 857	mm 16	mm 725/820	1,771.27
PARTY	411/78.1520.T	Mechanism + cover caps	mm 1200	560 mm	mm 150	mm 16/19	mm 1380	mm 1157	mm 16	mm 725/820	1,771.27

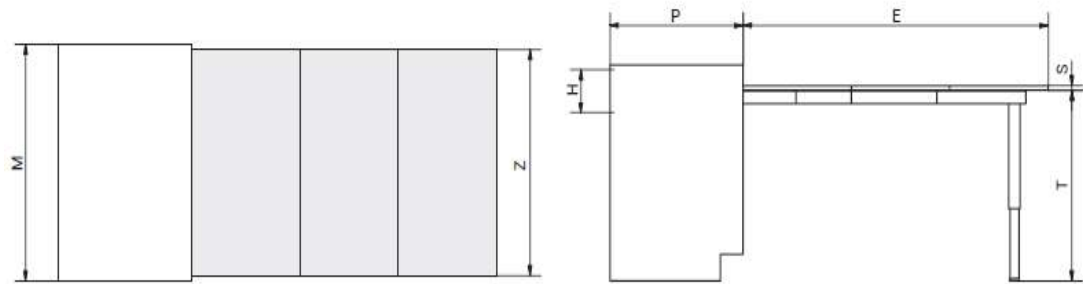

Link video: <https://youtu.be/m9pYXTsah5M>

MODEL	CODICE ATIM	Description	L module	P min	H min	S1	E	Z min	S	T	Цена в лева с ДДС
MENSOLA PARTY	411/78.1601.T	Mechanism + cover caps	mm 600	mm 502	mm 140	mm 18,5	mm 1540	mm 555	mm 14	mm 730/755	1,919.77
MENSOLA PARTY	411/78.1602.T	Mechanism + cover caps	mm 900	mm 502	mm 140	mm 18,5	mm 1540	mm 855	mm 14	mm 730/755	1,919.77
MENSOLA PARTY	411/78.1600.T	Mechanism + cover caps	mm 1200	mm 502	mm 140	mm 18,5	mm 1540	mm 1155	mm 14	mm 730/755	1,919.77

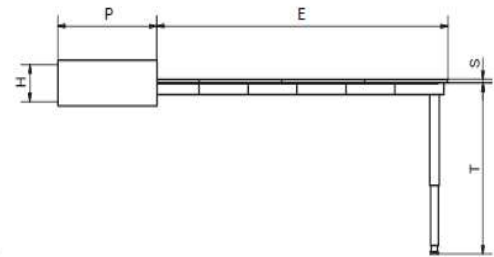
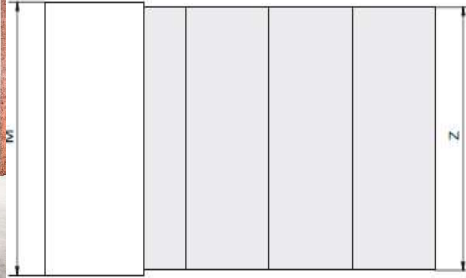

Link video:

<https://youtu.be/m9pYXTsah5M>

MODEL	CODICE ATIM	Description	M	P min	H min	S1	E	Z min	S min	T	Цена в лева с ДДС
EVOLUTION	411/78.1610.T	Mechanism + cover caps	mm 600	mm 520	mm 120	mm 15/20	mm 1040	mm 555	mm 16	mm 730/755	1,206.89
EVOLUTION	411/78.1611.T	Mechanism + cover caps	mm 900	mm 520	mm 120	mm 15/20	mm 1040	mm 855	mm 16	mm 730/755	1,206.89
EVOLUTION	411/78.1612.T	Mechanism + cover caps	mm 1200	mm 520	mm 120	mm 15/20	mm 1040	mm 1155	mm 16	mm 730/755	1,206.89

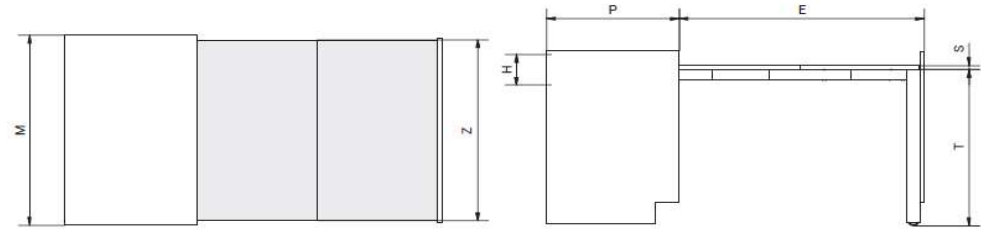

Link video: <https://youtu.be/FcpuaAAbTrI>

MODEL	CODICE ATIM	Description	M	P min	H min	S1	E	Z min	S min	T	Цена в лева с ДДС
EVOLUTION XL	411/78.1620.T	Mechanism + cover caps	mm 600	mm 520	mm 120	mm 15/20	mm 1520	mm 555	mm 16	mm 730/755	1,452.78
EVOLUTION XL	411/78.1621.T	Mechanism + cover caps	mm 900	mm 520	mm 120	mm 15/20	mm 1520	mm 855	mm 16	mm 730/755	1,452.78
EVOLUTION XL	411/78.1622.T	Mechanism + cover caps	mm 1200	mm 520	mm 120	mm 15/20	mm 1520	mm 1155	mm 16	mm 730/755	1,452.78

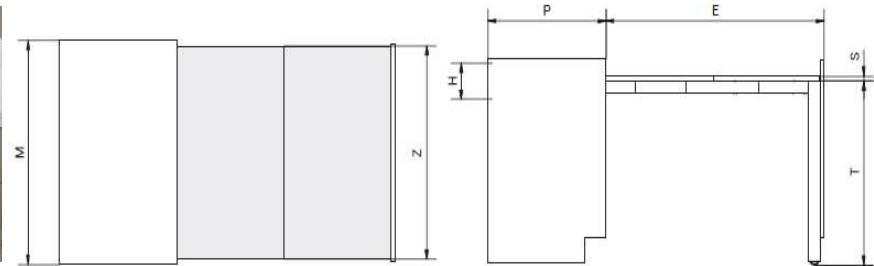

Link video:

<https://youtu.be/FcpuaAAbTrI>

MODEL	CODICE ATIM	Description	M	P min	H min	S1	E	Z min	S	ST	Цена в лева с ДДС
OPLA' TOP	411/78.1750.T	Mechanism + cover caps	mm 450	mm 540	mm 75	mm 15/20	mm 500	mm 405	mm 20/60	mm 20/60	632.11
OPLA' TOP	411/78.1760.T	Mechanism + cover caps	mm 600	mm 540	mm 75	mm 15/20	mm 500	mm 555	mm 20/60	mm 20/60	632.11
OPLA' TOP	411/78.1770.T	Mechanism + cover caps	mm 900	mm 540	mm 75	mm 15/20	mm 500	mm 855	mm 20/60	mm 20/60	632.11
OPLA' TOP	411/78.1780.T	Mechanism + cover caps	mm 1200	mm 540	mm 75	mm 15/20	mm 500	mm 1155	mm 20/60	mm 20/60	632.11

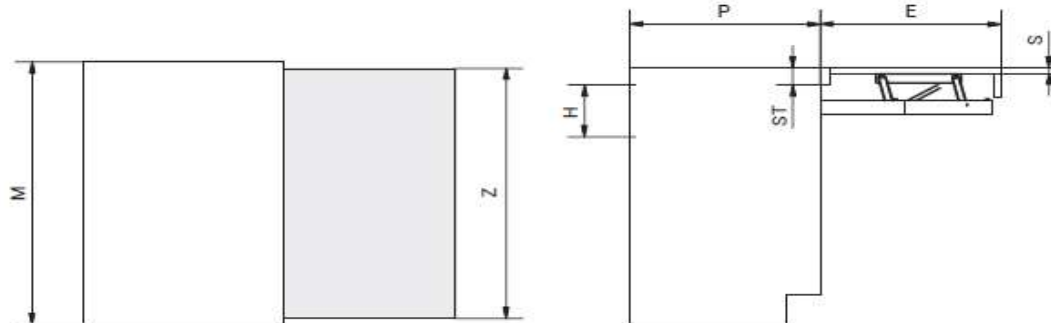

Link video:

<https://youtu.be/U4NYyWgkXGg>

MODEL	CODICE ATIM	Description	L min	P min	H min	S	Z	E	Цена в лева с ДДС
SANDWICH	411/78.1850.T	Mechanism + cover caps	mm 592	mm 540	mm 120	mm 18	mm 590	mm 510	851.46
SANDWICH	411/78.1860.T	Mechanism + cover caps	mm 802	mm 540	mm 120	mm 18	mm 800	mm 510	851.46
SANDWICH	411/78.1870.T	Mechanism + cover caps	mm 1102	mm 540	mm 120	mm 18	mm 1100	mm 510	851.46

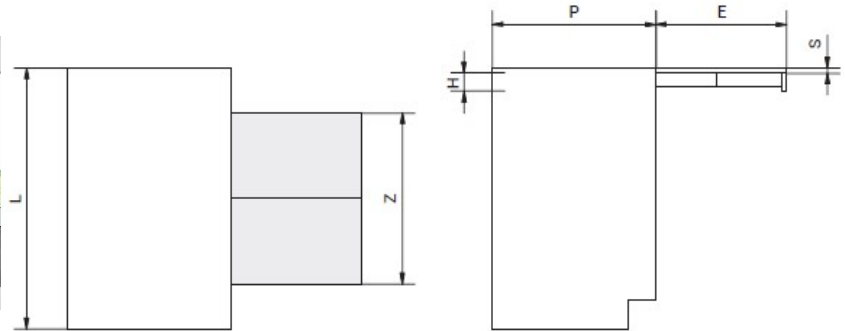

Link video: <https://youtu.be/wSYTXfKsf0g>

MODEL	CODICE ATIM	Description	M	P min	H min	S1	E	Z min	S min	Цена в лева с ДДС
FLIP TOP	411/78.1800.T	Mechanism + cover caps	mm 450	mm 540	mm 120	mm 15/20	mm 480	mm 450	mm 16	596.12
FLIP TOP	411/78.1810.T	Mechanism + cover caps	mm 600	mm 540	mm 120	mm 15/20	mm 480	mm 600	mm 16	596.12
FLIP TOP	411/78.1820.T	Mechanism + cover caps	mm 900	mm 540	mm 120	mm 15/20	mm 480	mm 900	mm 16	596.12
FLIP TOP	411/78.1830.T	Mechanism + cover caps	mm 1200	mm 540	mm 120	mm 15/20	mm 480	mm 1200	mm 16	596.12

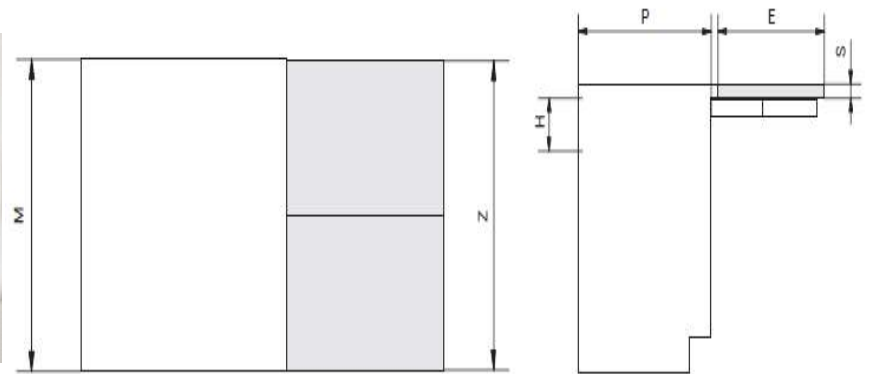

Link video: <https://youtu.be/6e6NmYHzL7g>

MODEL	CODICE ATIM	Description	M min	P min	H min	E	Z min	S min	Цена в лева с ДДС
BREAKFAST	411/78.1251.T	Mechanism + cover caps	mm 600	mm 1780	mm 80	mm 1600	mm 580	mm 18	2,080.97
BREAKFAST	411/78.1251.SMT	Mechanism + cover caps	mm 600	mm 1780	mm 100	mm 1600	mm 580	mm 18	8,337.84

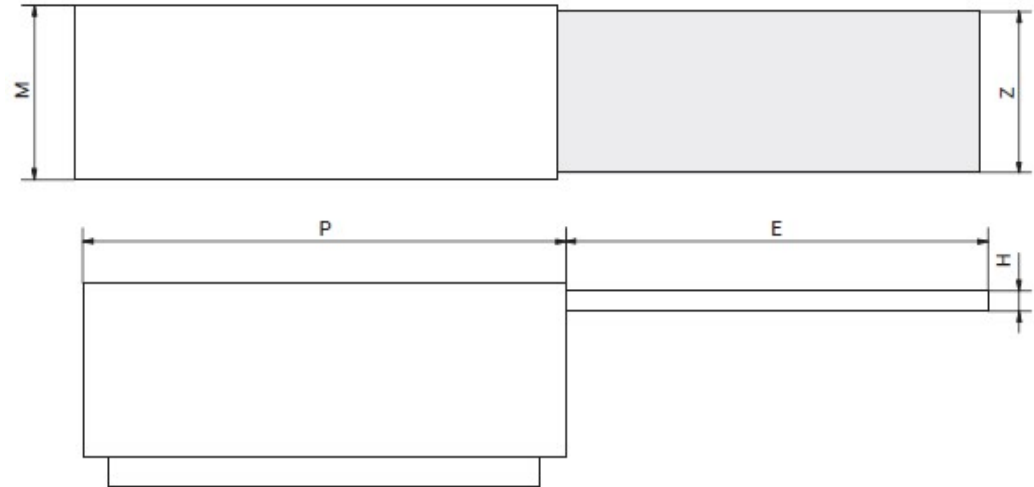

Link video:

<https://youtu.be/Tf-xxBkXaJl>

MODEL	CODICE ATIM	Description	P min	H min	Z min	E	S min	Цена в лева с ДДС
BREAKFAST TOP	411/78.1252.T	Mechanism + cover caps	mm 1200	mm 85	mm 850	mm 900	mm 18	2,080.96
BREAKFAST TOP	411/78.1253.T	Mechanism + cover caps	mm 1800	mm 85	mm 850	mm 1200	mm 18	2,080.96
BREAKFAST TOP	411/78.1254.T	Mechanism + cover caps	mm 2400	mm 85	mm 850	mm 1500	mm 18	2,080.96
BREAKFAST TOP	411/78.1255.T	Mechanism + cover caps	mm 3000	mm 85	mm 850	mm 1500	mm 18	2,080.96

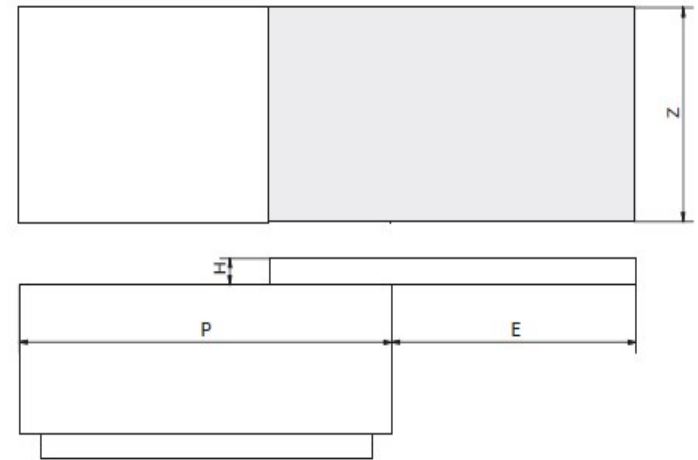

Link al video:

<https://www.youtube.com/watch?v=YD8l25lvsFs&t=20s>

MODEL	CODICE ATIM	Description	P min	H min	Z	L	S min	E	Цена в лева с ДДС
SLIDE QUADRATO	411/78.1241.T	Mechanism + cover caps	mm 1200	mm 75	mm 1200	mm 1200	mm 18	mm 350	1,435.45
SLIDE RETTANGOLARE DX	411/78.1242.T	Mechanism + cover caps	mm 950	mm 75	mm 1200	mm 950	mm 18	mm 350	1,435.45
SLIDE RETTANGOLARE SX	411/78.1243.T	Mechanism + cover caps	mm 950	mm 75	mm 1200	mm 950	mm 18	mm 350	1,435.45
SLIDE QUADRATO	411/78.1245.T	Mechanism + cover caps	mm 900	mm 75	mm 900	mm 900	mm 18	mm 315	1,435.45

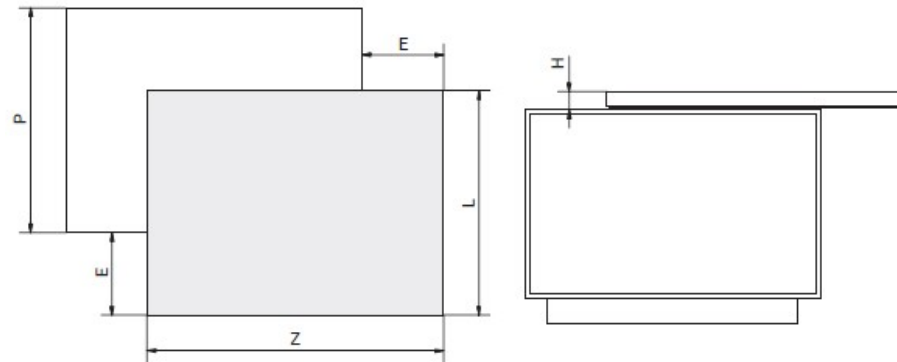

Link video:

<https://youtu.be/iPROC2mN2OY>

MODEL	CODICE ATIM	Description	L module	P min	H min	S1 min	E	S min	Z	Цена в лева с ДДС
SNACK	411/78.1281.T	Mechanism + cover caps	mm 2467	mm 800	mm 80	mm 40	mm 640	mm 18	mm 2460	1,070.31
SNACK	411/78.1282.T	Mechanism + cover caps	mm 1867	mm 800	mm 80	mm 40	mm 640	mm 18	mm 1860	1,070.31
SNACK	411/78.1281 SMT	Mechanism + cover caps	mm 2467	mm 800	mm 90	mm 40	mm 590	mm 18	mm 2460	8,396.15
SNACK	411/78.1282 SMT	Mechanism + cover caps	mm 1867	mm 800	mm 90	mm 40	mm 590	mm 18	mm 1860	8,396.15

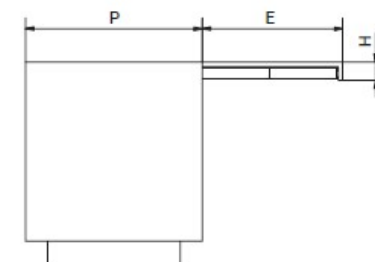
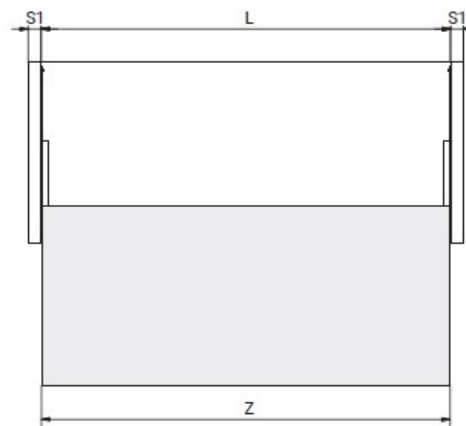

Link video: <https://youtu.be/DnBBXqMzCEc>

MODEL	CODICE ATIM	Description	L module	Z min	L min	E	H min.	S min	Цена в лева с ДДС
SNACK TOP	411/78.1283.22	Mechanism	mm 900	mm 900	mm 900	mm 500	mm 65	mm 18	1,107.70
SNACK TOP	411/78.1284.22	Mechanism	mm 1200	mm 1200	mm 1200	mm 700	mm 65	mm 18	1,285.25
SNACK TOP AIR SELF CLOSING	411/78.1283.22 A	Mechanism	mm 900	mm 900	mm 900	mm 500	mm 65	mm 18	1,261.40
SNACK TOP AIR SELF CLOSING	411/78.1284.22 A	Mechanism	mm 1200	mm 1200	mm 1200	mm 700	mm 65	mm 18	1,438.95

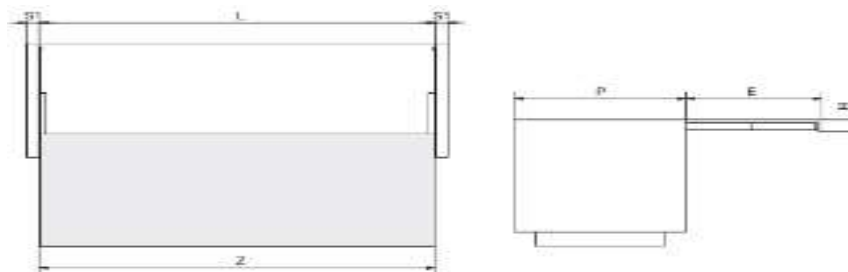

CODICE CODE	L	P MM	H	S1 MM	E	S MM	Z
411/78.1283.22	2467	800	80	40	600	18	2460
411/78.1284.22	1867	800	80	40	600	18	1860
411/78.1283.22 SM	2467	800	90	40	500	18	2460
411/78.1284.22 SM	1867	800	90	40	500	18	1860

Values expressed in millimeters - Value expressed in millimeters

MODEL	CODICE ATIM	Description	P min	H min	E	L max	Z	T	Цена в лева с ДДС
FLAP	411/78.1244.22	Mechanism	mm 950	mm 55	mm 600	mm 600/1300	mm 950	mm 450	1,406.55
FLAP	411/78.1244.22 C	Mechanism	mm 950	mm 55	mm 300	mm 600/1300	mm 950	mm 450	1,406.55

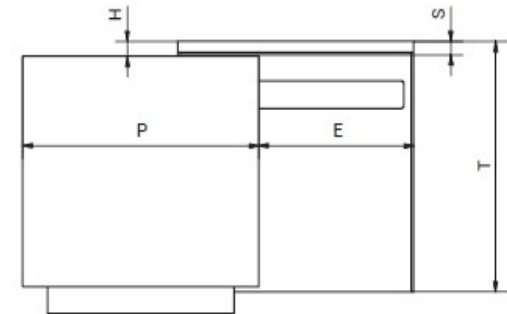
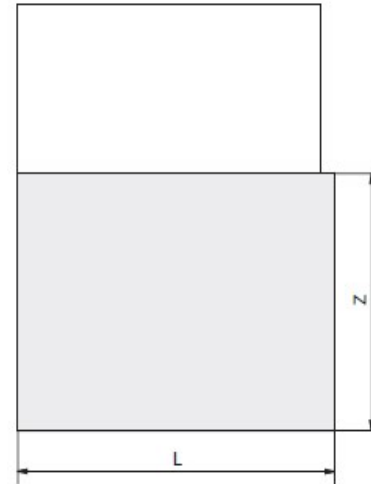

Link video: <https://youtu.be/S3t-Dldr9qU>

MODEL	CODICE ATIM	Description	P min	L	Z	E	Цена в лева с ДДС
CORNER 1200X1200	78.1230.T	Mechanism + cover caps	1200	1200	1200	350	1,022.26
CORNER 1200X900 RIGHT	78.1231.T	Mechanism + cover caps	900	1200	1200	350	1,022.26
CORNER 1200X900 LEFT	78.1232.T	Mechanism + cover caps	900	1200	1200	350	1,022.26
CORNER 900X900	78.1233.T	Mechanism + cover caps	900	900	900	300	1,022.26
CORNER 900X600 RIGHT	78.1234.T	Mechanism + cover caps	600	900	900	300	1,022.26
CORNER 900X600 LEFT	78.1235.T	Mechanism + cover caps	600	900	900	300	1,022.26

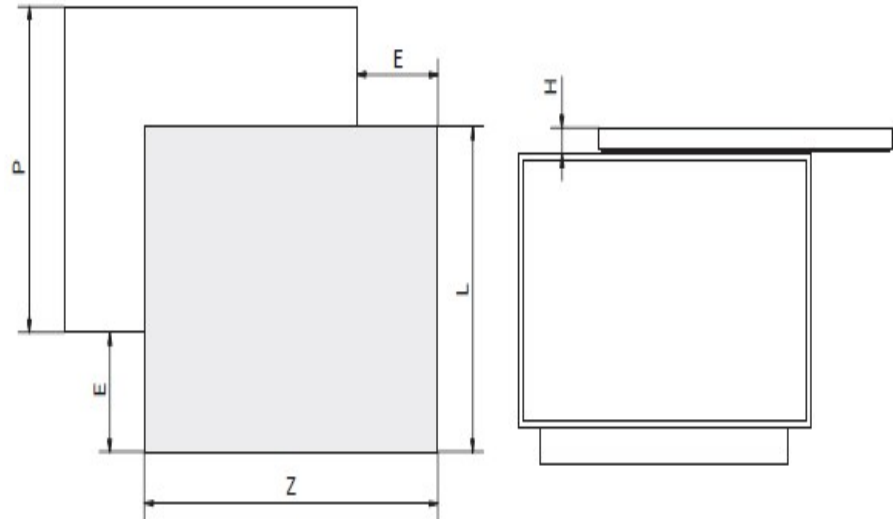

Link video:

<https://youtu.be/iPROC2mN2OY>

MODEL	CODICE ATIM	Description	P min	H min	Z min	M max	S min	E max	Цена в лева с ДДС
TWICE	78.1480.T	Mechanism + cover caps	600	80	600	1200	18	600	1,022.90

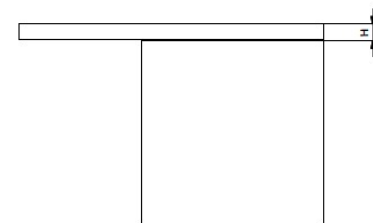
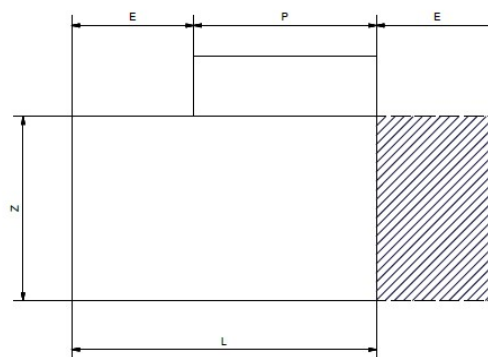

MODEL	CODICE ATIM	Description		P	H min	Z min	L	S min	E	Цена в лева с ДДС
TWICE TOP	411/78.1470.25	Mechanism + cover caps		900	80	900	1500	18	600	1,195.15
				1200	80	900	1500	18	600	

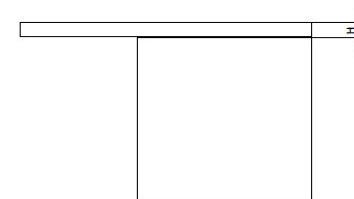
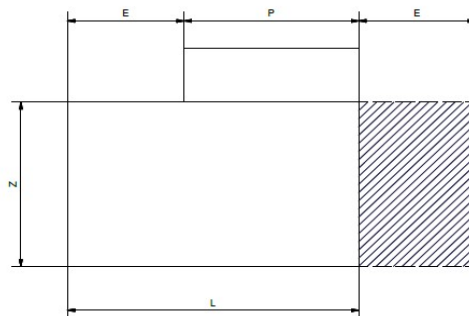

MODEL	CODICE ATIM	Description		P	H min	Z min	L	S min	E	Цена в лева с ДДС
TOP 33	411/78.1270.22	Mechanism		900	45	1800	900	12	610	1,653.60
TOP 33	411/78.1271.22	Mechanism		1200	45	1800	1200	12	710	1,653.60

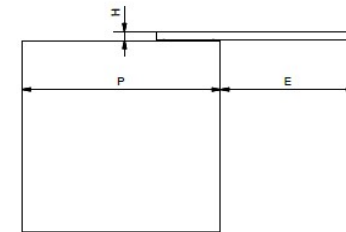
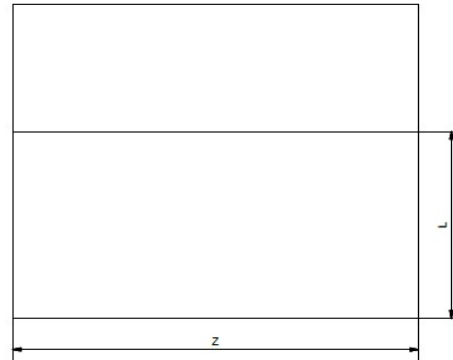

MODEL	CODICE ATIM	Description	M	P min	E	Z	S	ST	T	Крак	Цена в лева с ДДС
VOILA'	411/78.1190.T	Mechanism + cover caps	mm 900	mm 660	mm 570	mm 900	mm 20/40	mm 20/40	mm 865/890	mm 60x60	1,725.95
VOILA'	411/78.1194.25	Mechanism	mm 800	mm 660	mm 570	mm 800	mm 20/40	mm 20/40	mm 865/890	mm 60x60	1,710.68
VOILA'	411/78.1195.25	Mechanism	mm 955	mm 660	mm 570	mm 955	mm 20/40	mm 20/40	mm 865/890	mm 60x60	1,710.68

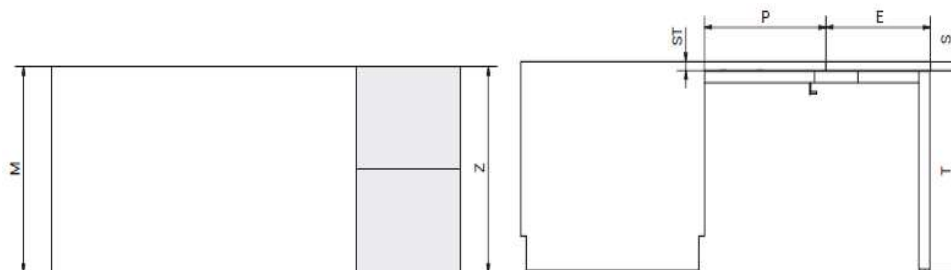
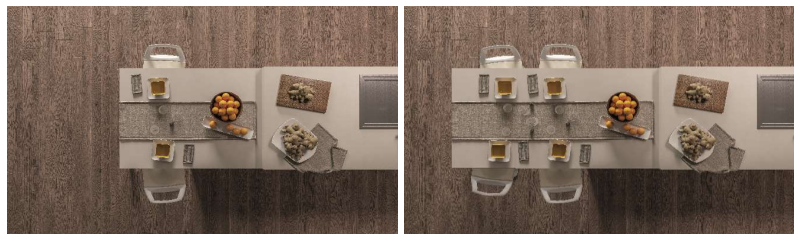

Link video: <https://youtu.be/sgJ5q4VIngE>

MODEL	CODICE ATIM	Description	M	P min	E	Z	S	ST	T	Крак	Цена в лева с ДДС
VOILÁ CHAIR	411/78.1330.T	Mechanism + cover caps	700	800	650	700	18/20	18/20	710/735	72x45	1,962.75
VOILÁ CHAIR	411/78.1331.T	Mechanism + cover caps	700	900	650	800	18/20	18/20	710/735	72x45	1,962.75
VOILÁ CHAIR	411/78.1332.T	Mechanism + cover caps	700	1000	650	900	18/20	18/20	710/735	72x45	1,962.75
VOILÁ CHAIR	411/78.1333.T	Mechanism + cover caps	800	800	650	700	18/20	18/20	710/735	72x45	1,962.75
VOILÁ CHAIR	411/78.1334.T	Mechanism + cover caps	800	900	650	800	18/20	18/20	710/735	72x45	1,962.75
VOILÁ CHAIR	411/78.1335.T	Mechanism + cover caps	800	1000	650	900	18/20	18/20	710/735	72x45	1,962.75
VOILÁ CHAIR	411/78.1336.T	Mechanism + cover caps	900	800	650	700	18/20	18/20	710/735	72x45	1,962.75
VOILÁ CHAIR	411/78.1337.T	Mechanism + cover caps	900	900	650	800	18/20	18/20	710/735	72x45	1,962.75
VOILÁ CHAIR	411/78.1338.T	Mechanism + cover caps	900	1000	650	900	18/20	18/20	710/735	72x45	1,962.75

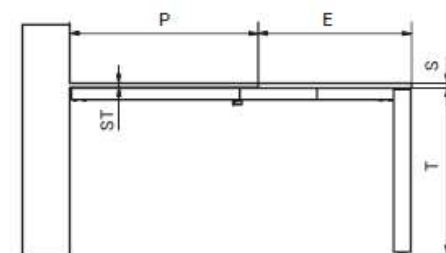
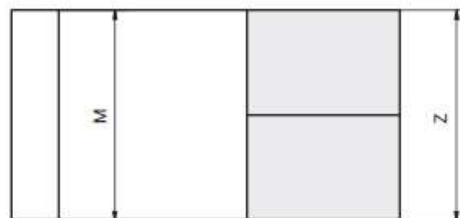

MODEL	CODICE ATIM	Description	M	P	Z	S	ST	E max	T	Крак	Цена в лева с ДДС
VOILÁ CHAIR REVERSE	411/78.1320.T	Mechanism + cover caps	700	1100	700	18	18	1100	710/735	72x45	1,986.92
VOILÁ CHAIR REVERSE	411/78.1321.T	Mechanism + cover caps	700	1300	700	18	18	1300	710/735	72x45	1,986.92
VOILÁ CHAIR REVERSE	411/78.1322.T	Mechanism + cover caps	800	1100	800	18	18	1100	710/735	72x45	1,986.92
VOILÁ CHAIR REVERSE	411/78.1323.T	Mechanism + cover caps	800	1300	800	18	18	1300	710/735	72x45	1,986.92
VOILÁ CHAIR REVERSE	411/78.1324.T	Mechanism + cover caps	900	1100	900	18	18	1100	710/735	72x45	1,986.92
VOILÁ CHAIR REVERSE	411/78.1325.T	Mechanism + cover caps	900	1300	900	18	18	1300	710/735	72x45	1,986.92

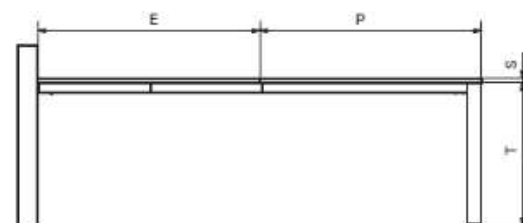
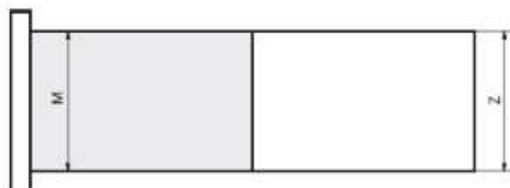

MODEL	CODICE ATIM	Description	M min	P min	H1	H min.	Z	Цена в лева с ДДС
DINAMICO gola mm 4300 con Voilà Flag 800x800 > 1370x800 top mm 20	78.1192.25	Mechanism	check the catalogue	check the catalogue	885	80	800	2,576.86
DINAMICO gola mm 4300 con Voilà Flag 800x800 > 1370x800 top mm 40	78.1193.25	Mechanism	check the catalogue	check the catalogue	885	80	800	2,576.86
DINAMICO gola mm 4300 con 2 gambe HOP	411/78.1196.25	Mechanism	check the catalogue	check the catalogue	885	80	800	1,476.32
DINAMICO gola mm 4300	411/78.1301.25	Mechanism	check the catalogue	check the catalogue	885	80	800	866.02

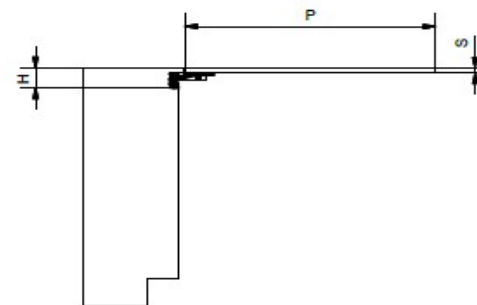
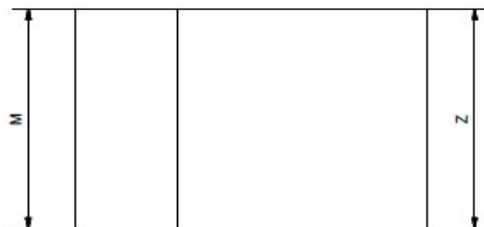

MODEL	CODICE ATIM	Description	P	L	T	H	E	E1	Z	S min	Цена с фикс. крак	Цена с рег. крак
SESTANTE	411/78.1290.22	Mechanism	600	1500	930	50	900	300	600	18	1,584.70	1,833.80
SESTANTE	411/78.1291.22	Mechanism	700	1500	930	50	900	400	700	18	1,584.70	1,833.80
SESTANTE	411/78.1292.22	Mechanism	800	1500	930	50	900	500	800	18	1,616.50	1,865.60
SESTANTE	411/78.1293.22	Mechanism	900	1500	930	50	900	600	900	18	1,616.50	1,865.60
SESTANTE	411/78.1294.22	Mechanism	1200	1500	930	50	900	600	1200	18	1,648.30	1,897.40
SESTANTE	411/78.129X.22	Mechanism	UNIVERSALE	1500	UNIVERSALE	50	900	da 300 a 600	UNIVERSALE	18	1,616.50	1,865.60

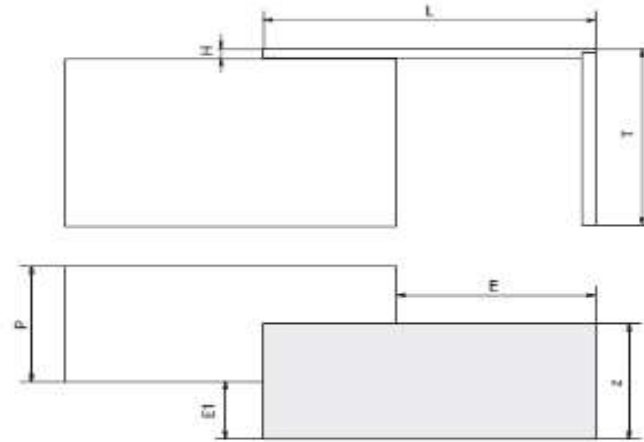

MODEL	CODICE ATIM	Description	M	P min	H min	S1	E	S min	Z min	T	Цена в лева с ДДС
EVOLUTION +39	411/39.1610.T	Mechanism + cover caps	mm 600	mm 390	mm 150	mm 15/20	mm 690	mm 16	mm 555	mm 730/755	1,217.07
EVOLUTION +39	411/39.1611.T	Mechanism + cover caps	mm 900	mm 390	mm 150	mm 15/20	mm 690	mm 16	mm 855	mm 730/755	1,217.07
EVOLUTION +39	411/39.1612.T	Mechanism + cover caps	mm 1200	mm 390	mm 150	mm 15/20	mm 690	mm 16	mm 1155	mm 730/755	1,217.07

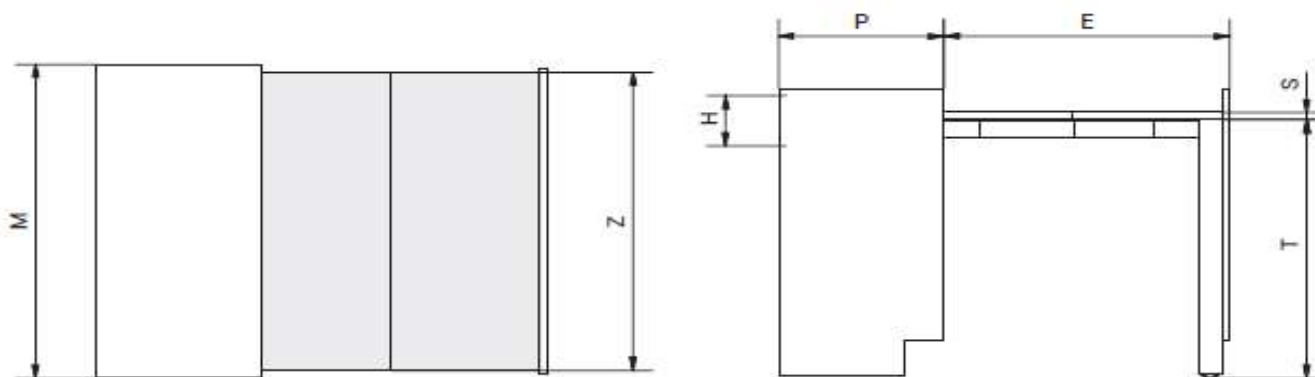

MODEL	CODICE ATIM	Description	M	P min	H min	S1	E	Z min	S min	T	Цена в лева с ДДС
EVOLUTION XL +39	411/39.1620.T	Mechanism + cover caps	mm 600	mm 520	mm 150	mm 15/20	mm 1040	mm 555	mm 16	mm 730/755	1,452.78
EVOLUTION XL +39	411/39.1621.T	Mechanism + cover caps	mm 900	mm 520	mm 150	mm 15/20	mm 1040	mm 855	mm 16	mm 730/755	1,452.78
EVOLUTION XL +39	411/39.1622.T	Mechanism + cover caps	mm 1200	mm 520	mm 150	mm 15/20	mm 1040	mm 1155	mm 16	mm 730/755	1,452.78

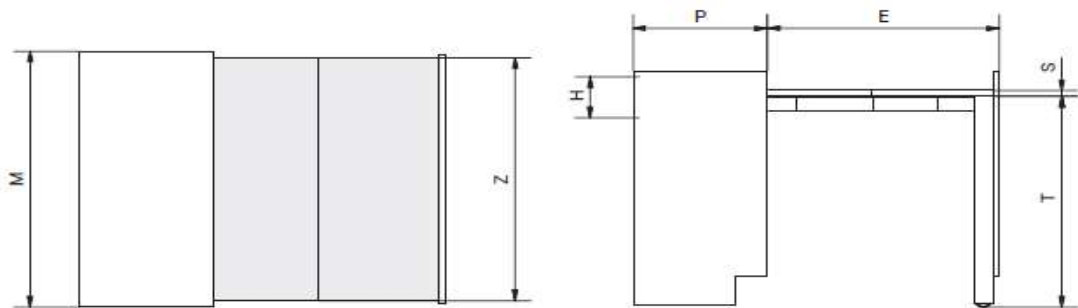

Link video:

<https://www.youtube.com/watch?v=A6MTmEdkXzI>

MODEL	CODICE ATIM	Description	M	P min	H	S1	E	Z min	S min	Цена в лева с ДДС
HOMEWORK +39	411/39.1200.T	Mechanism + cover caps	mm 600	mm 390	mm 54	mm 15/20	mm 1015	mm 555	mm 16	680.28
HOMEWORK +39	411/39.1210.T	Mechanism + cover caps	mm 900	mm 390	mm 54	mm 15/20	mm 1015	mm 855	mm 16	680.28
HOMEWORK +39	411/39.1220.T	Mechanism + cover caps	mm 1200	mm 390	mm 54	mm 15/20	mm 1015	mm 1155	mm 16	680.28

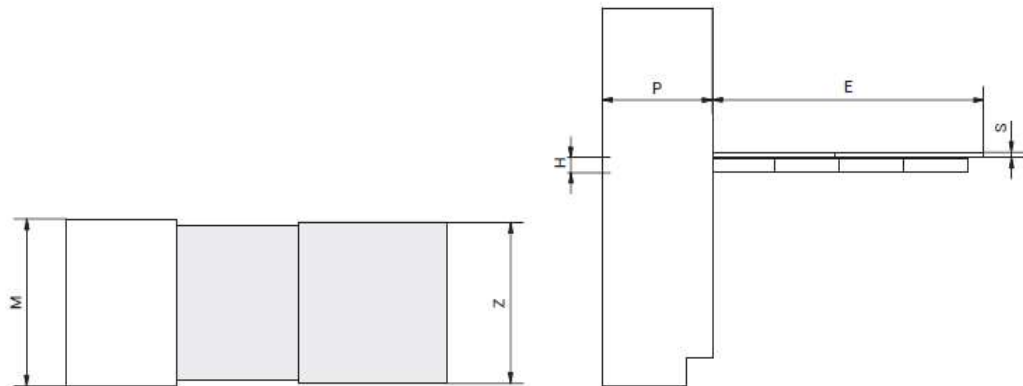

MODEL	CODICE ATIM	Description	M	P min	H min	S1	E	Z min	S min	Цена в лева с ДДС
LUNCH +39	411/39.1100.T	Mechanism + cover caps	mm 450/1200	mm 390	mm 120	mm 15/20	mm 705	mm 405/1155	mm 16	568.70

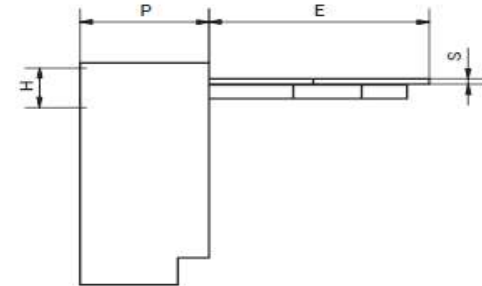
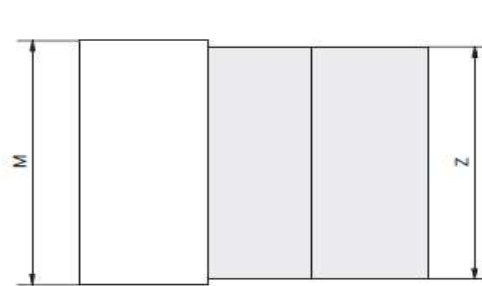

MODEL	CODICE ATIM	Description	M	P min	H min	S1	E	Z min	S min	T	Цена в лева с ДДС
MENSOLA T-ABLE +39	411/39.1920.XT	Mechanism + cover caps	mm 1200	mm 390	mm 180	mm 15/20	mm 1350	mm 1155	mm 14	mm 712/737	1,138.28

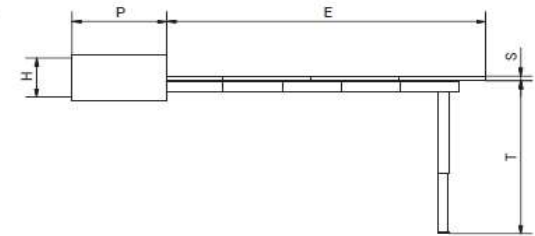
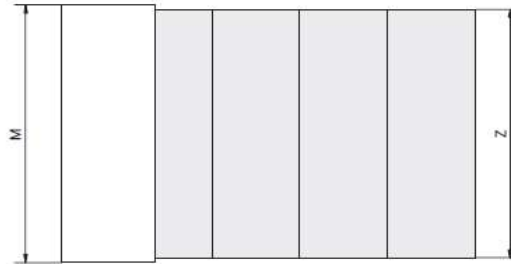

Link Video: <https://youtu.be/HoxTzHVkaH4>

MODEL	CODICE ATIM	Description	M	P min	H min	S1	E	S	ST	Z	Цена в лева с ДДС
OPLA' +39	411/39.1700.T	Mechanism + cover caps	mm 450-1000	mm 390	mm 100	mm 15/20	mm 370	mm 18/22	mm 18/22	mm 405/955	632.10
OPLA' +39	411/39.1720.T	Mechanism + cover caps	mm 1200	mm 390	mm 100	mm 15/20	mm 370	mm 18/22	mm 18/22	mm 1155	632.10

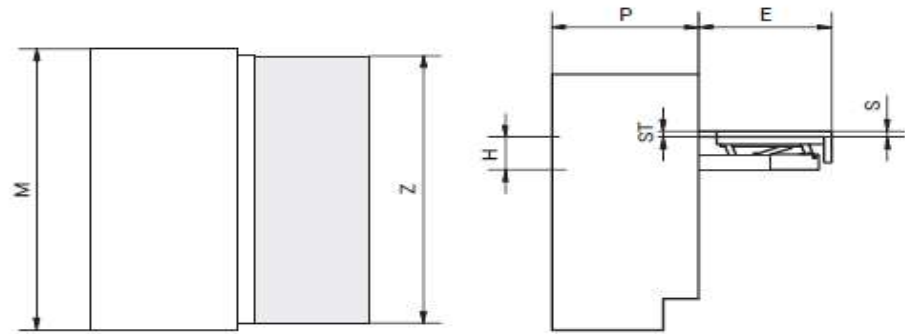

Link video:

<https://youtu.be/Nkk51XKxMTU>

MODEL	CODICE ATIM	Description	M	P min	H min	S1	E	Z	S	ST	Цена в лева с ДДС
OPLA' FOLDING +39	411/39.1700.FT	Mechanism + cover caps	mm 450/1000	mm 390	mm 205	mm 15/20	mm 370	mm 405/955	mm 16/25	mm 16/25	721.22
OPLA' FOLDING +39	411/39.1720.FT	Mechanism + cover caps	mm 1200	mm 390	mm 205	mm 15/20	mm 370	mm 1155	mm 16/25	mm 16/25	721.22

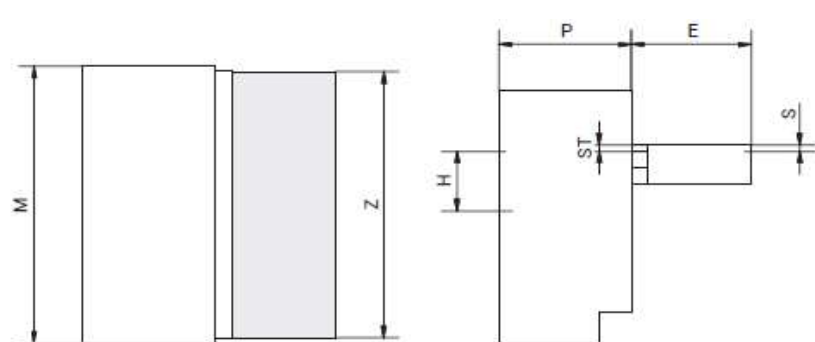

Link video:

<https://youtu.be/JQlc72Az8BU>

MODEL	CODICE ATIM	Description	M	P min	H min	S1	E	S min	Z min	T	Цена в лева с ДДС
T-BENCH +39	411/39.1950.T	Mechanism + cover caps	mm 450	mm 390	mm 120	mm 15/20	mm 705	mm 16	mm 405	mm 395/420	835.60
T-BENCH +39	411/39.1960.T	Mechanism + cover caps	mm 600	mm 390	mm 120	mm 15/20	mm 705	mm 16	mm 555	mm 395/420	835.60

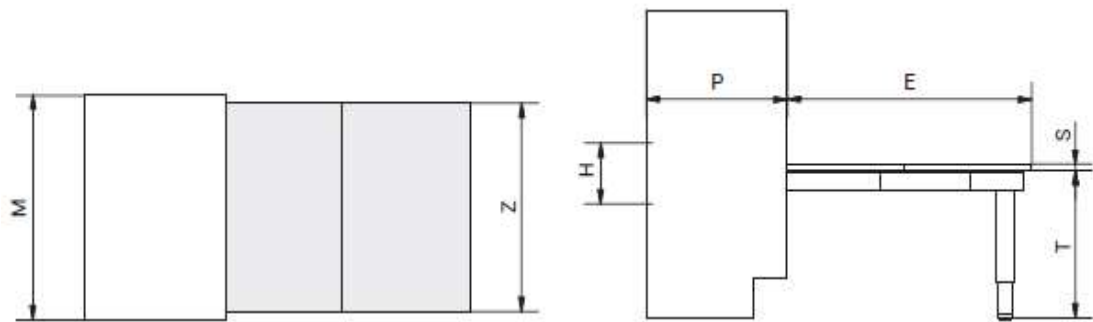

Link Video: <https://youtu.be/O0dmFN-ei5g>

MODEL	CODICE ATIM	Description	M min	P min	H min	S1	E	Z min	S min	Цена в лева с ДДС
SHOT +39	411/39.1130.25	Mechanism	450	390	90	15/20	325	405	16	334.43
SHOT +39	411/39.1130.25 F	Mechanism	450	390	90	15/20	325	405	16	334.43
SHOT +39	411/39.1130.T	Mechanism	450	390	90	15/20	325	405	16	349.69
SHOT +39	411/39.1130.FT	Mechanism	450	390	90	15/20	325	405	16	349.69

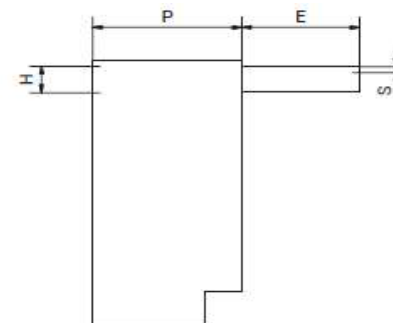
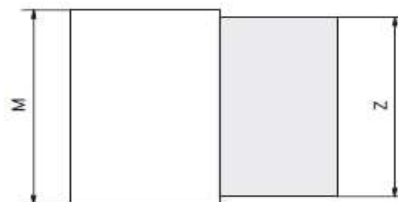

MODEL	CODICE ATIM	Description	M min	P min	H min	E	Z	Цена в лева с ДДС
PRUA	411/78.1180.T	Mechanism + cover caps	mm 360	535 mm	mm 150	mm 885	mm 350	859.20
PRUA SHORT	411/78.1181.T	Mechanism + cover caps	mm 330	450 mm	mm 140	mm 840	mm 350	859.20
CAMBIO TELO								

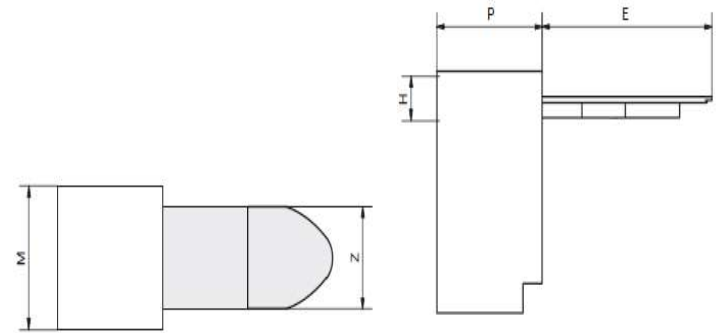

Link video: <https://youtu.be/yI5iTCKvDNs>

MODEL	CODICE ATIM	Description	M	P min	H min	S1	E	Z	T	Цена в лева с ДДС
PRUA LIFT	411/78.1186.02	Mechanism	350	390	1100	15/20	1050	280	820	368.09
PRUA LIFT	411/78.1187.02	Mechanism	450	390	1100	15/20	1050	380	820	368.09

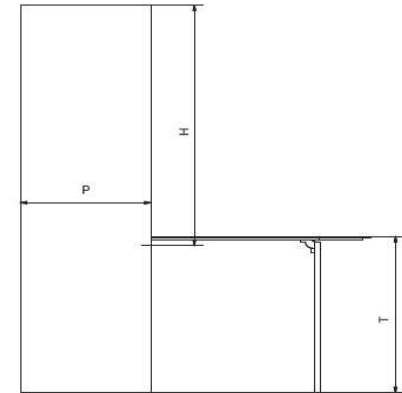
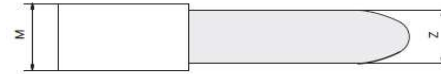

MODEL	CODICE ATIM	Description	M	P min.	H min.	Z	E	Цена в лева с ДДС	Equipment
PRUA SWING	411/78.1182.22	Mechanism	mm 1200	mm 450	mm 90	mm 350	mm 620	383.19	с плот и калъф

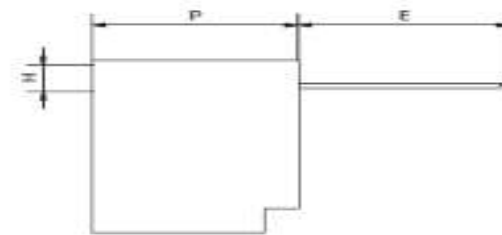
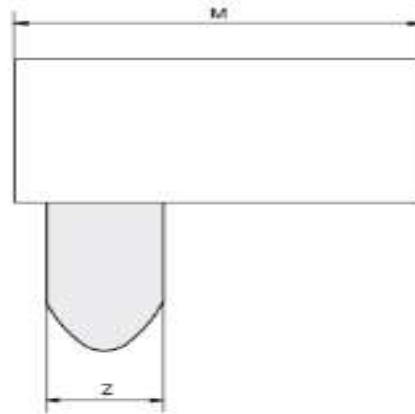

MODEL	CODICE ATIM	Description	M	P min	H min.	S1	E	Z	S min	Цена в лева с ДДС
BASKET <u>SILENT</u>	78.1183.25	Mechanism	mm 450	mm 450	mm 690	mm 15/20	mm 350	mm 405	mm 16	418.70
BASKET <u>SILENT</u>	78.1184.25	Mechanism	mm 600	mm 450	mm 690	mm 15/20	mm 350	mm 555	mm 16	424.00
BASKET <u>SILENT</u>	78.1185.25	Mechanism	mm 900	mm 450	mm 690	mm 15/20	mm 350	mm 855	mm 16	437.25
BASKET <u>SILENT</u>	78.1186.25	Mechanism	mm 1200	mm 450	mm 690	mm 15/20	mm 350	mm 1155	mm 16	437.25
BASKET <u>SILENT</u>	78.1183.C	Mechanism + 2 hinges	mm 450	mm 450	mm 690	mm 15/20	mm 350	mm 405	mm 16	442.34
BASKET <u>SILENT</u>	78.1184.C	Mechanism + 2 hinges	mm 600	mm 450	mm 690	mm 15/20	mm 350	mm 555	mm 16	447.64
BASKET <u>SILENT</u>	78.1185.C	Mechanism + 3 hinges	mm 900	mm 450	mm 690	mm 15/20	mm 350	mm 855	mm 16	472.71
BASKET <u>SILENT</u>	78.1186.C	Mechanism + 3 hinges	mm 1200	mm 450	mm 690	mm 15/20	mm 350	mm 1155	mm 16	472.71
BASKET <u>SILENT</u>	78.1183.T	Mechanism + cover caps	mm 450	mm 450	mm 690	mm 15/20	mm 350	mm 405	mm 16	428.88
BASKET <u>SILENT</u>	78.1184.T	Mechanism + cover caps	mm 600	mm 450	mm 690	mm 15/20	mm 350	mm 555	mm 16	434.18
BASKET <u>SILENT</u>	78.1185.T	Mechanism + cover caps	mm 900	mm 450	mm 690	mm 15/20	mm 350	mm 855	mm 16	447.43
BASKET <u>SILENT</u>	78.1186.T	Mechanism + cover caps	mm 1200	mm 450	mm 690	mm 15/20	mm 350	mm 1155	mm 16	447.43
BASKET <u>SILENT</u>	78.1183.TC	Mechanism + cover caps + 2 hinges	mm 450	mm 450	mm 690	mm 15/20	mm 350	mm 405	mm 16	452.51
BASKET <u>SILENT</u>	78.1184.TC	Mechanism + cover caps + 2 hinges	mm 600	mm 450	mm 690	mm 15/20	mm 350	mm 555	mm 16	469.63
BASKET <u>SILENT</u>	78.1185.TC	Mechanism + cover caps + 3 hinges	mm 900	mm 450	mm 690	mm 15/20	mm 350	mm 855	mm 16	482.88
BASKET <u>SILENT</u>	78.1186.TC	Mechanism + cover caps + 3 hinges	mm 1200	mm 450	mm 690	mm 15/20	mm 350	mm 1155	mm 16	471.06
BASKET <u>SILENT</u>	78.1183.25 P	Mechanism + woo hinged panel	mm 450	mm 450	mm 690	mm 15/20	mm 350	mm 405	mm 16	699.60
BASKET <u>SILENT</u>	78.1184.25 P	Mechanism + woo hinged panel	mm 600	mm 450	mm 690	mm 15/20	mm 350	mm 555	mm 16	638.65
BASKET <u>SILENT</u>	78.1185.25 P	Mechanism + woo hinged panel	mm 900	mm 450	mm 690	mm 15/20	mm 350	mm 855	mm 16	681.05
BASKET <u>SILENT</u>	78.1186.25 P	Mechanism + woo hinged panel	mm 1200	mm 450	mm 690	mm 15/20	mm 350	mm 1155	mm 16	693.24

